

# Ergotron® LX

## Dual Side by Side Arm

Dimensional &  
Range of Motion  
Illustrations

### Dimensions

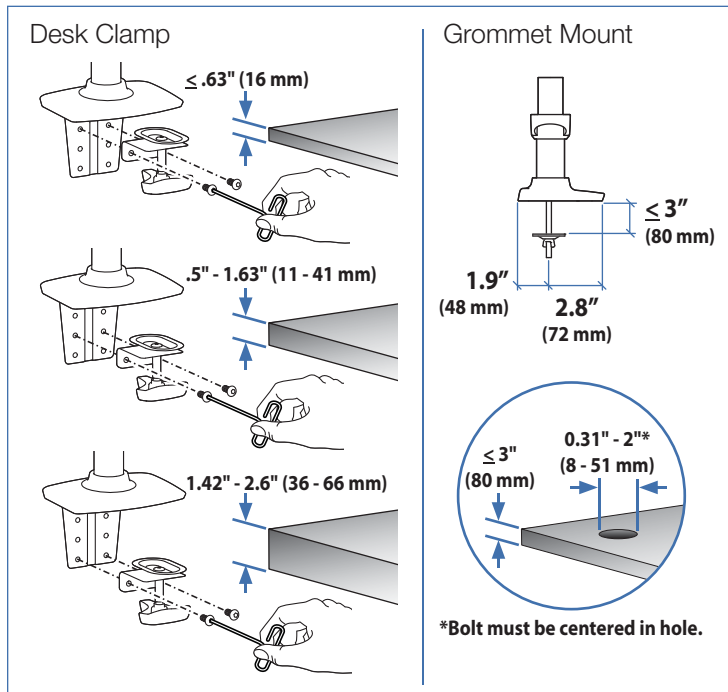
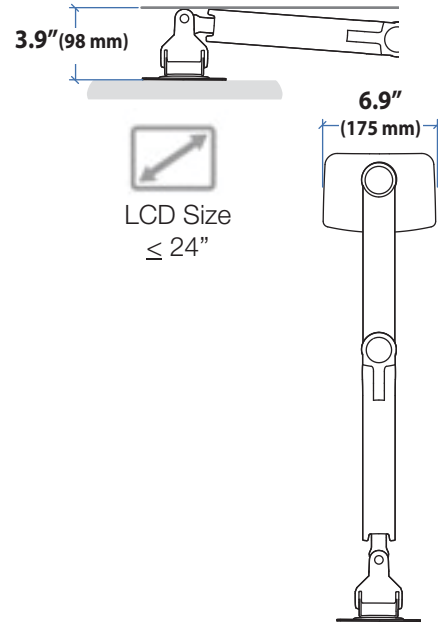
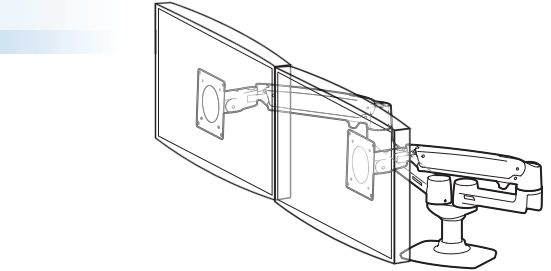
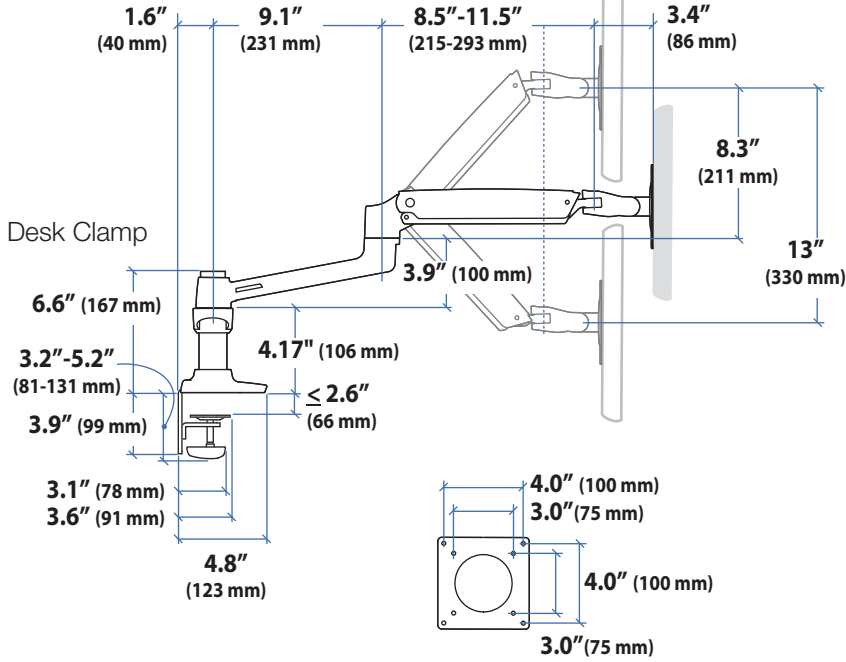

© 2013 Ergotron, Inc. rev. 06/04/2013 DIM2-LXSxS Content is subject to change without notification

**Americas Sales and Corporate Headquarters**

St. Paul, MN USA  
(800) 888-8458  
+1-651-681-7600  
www.ergotron.com  
sales@ergotron.com

**EMEA Sales**

Amersfoort, The Netherlands  
+31 33 45 45 600  
www.ergotron.com  
info.eu@ergotron.com

**APAC Sale**

Tokyo, Japan  
www.ergotron.com  
apaccustomerservice@ergotron.com

**Worldwide OEM Sales**

www.ergotron.com  
info.oem@ergotron.com



# Ergotron® LX

## Dual Side by Side Arm

Dimensional &  
Range of Motion  
Illustrations

### Range of Motion

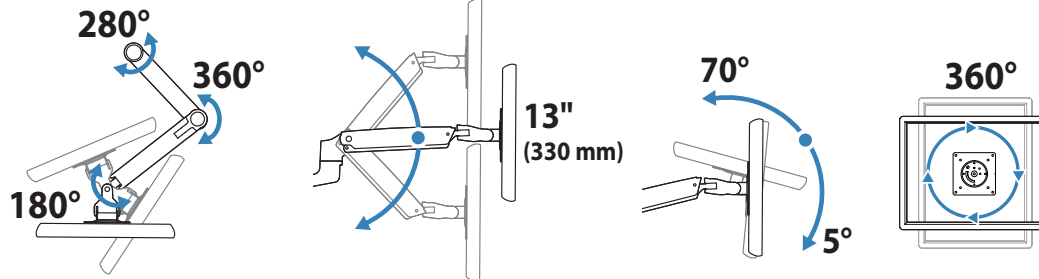

### Weight Capacity

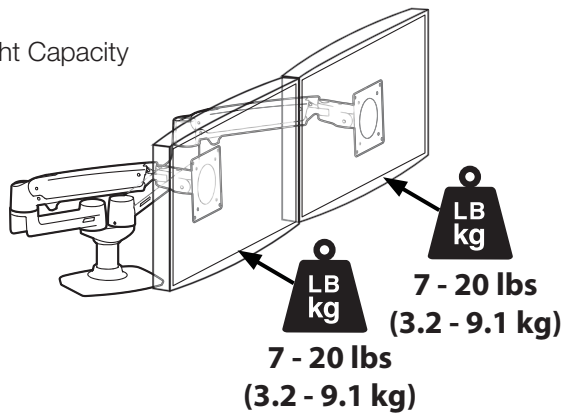

Monitor depth greater than 2.5" (64 mm) may diminish capacity.  
Call Ergotron for more information.

© 2013 Ergotron, Inc. rev. 06/04/2013 DIM2-LXSxS Content is subject to change without notification

#### Americas Sales and Corporate Headquarters

St. Paul, MN USA  
(800) 888-8458  
+1-651-681-7600  
www.ergotron.com  
sales@ergotron.com

#### EMEA Sales

Amersfoort, The Netherlands  
+31 33 45 45 600  
www.ergotron.com  
info.eu@ergotron.com

#### APAC Sale

Tokyo, Japan  
www.ergotron.com  
apaccustomerservice@ergotron.com

#### Worldwide OEM Sales

www.ergotron.com  
info.oem@ergotron.com

