

Ergotron® Neo-Flex™

Dimensional &
Range of Motion
Illustrations

Neo-Flex Dual Display Lift Stand

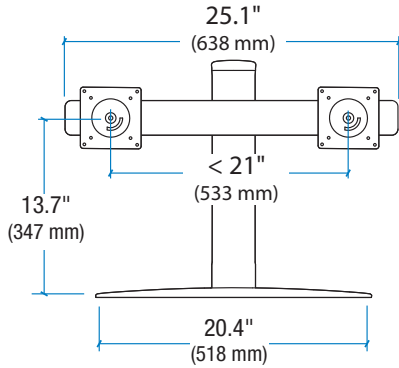

Front View

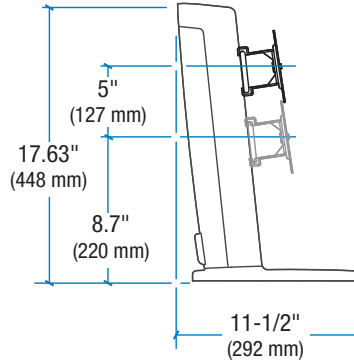

Side View

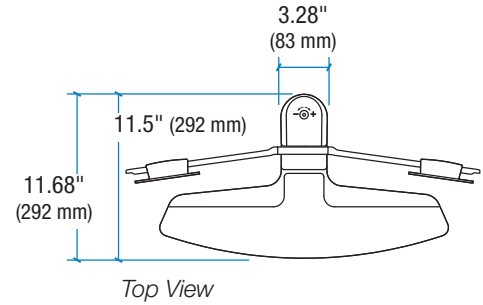

Top View

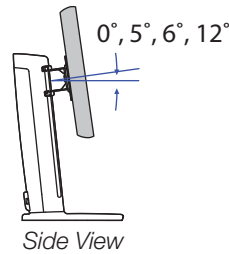
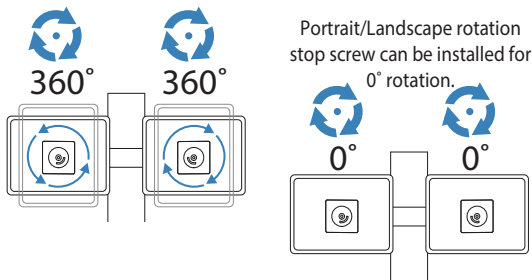

Side View

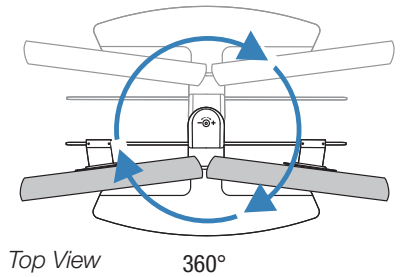

Top View

360°

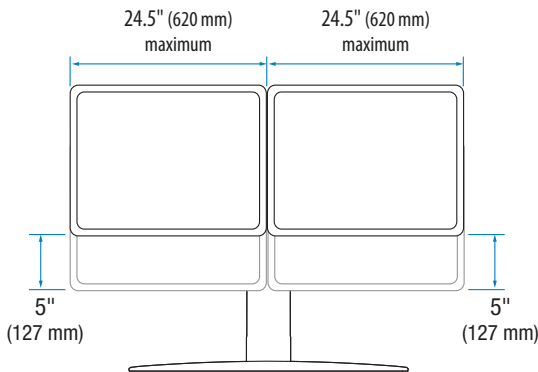

Front View

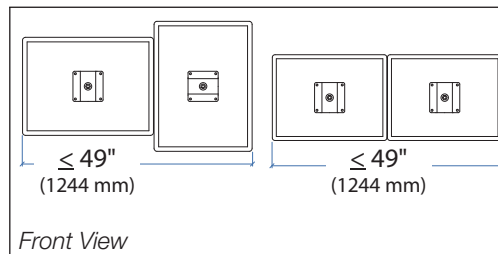

Front View

This range accommodates most displays with screens up to 24" as well as some displays with screens as large as 26".
Actual allowable width of displays will vary slightly depending on display thickness.
Note that older versions of this product used a narrower crossbar, which accommodated monitors with screens of up to 22"

© 2014 Ergotron, Inc. rev. 06/05/2014 DIM-NFDualStand Content is subject to change without notification

Americas Sales and Corporate Headquarters

St. Paul, MN USA
(800) 888-8458
+1-651-681-7600
www.ergotron.com
sales@ergotron.com

EMEA Sales

Amersfoort, The Netherlands
+31 33 45 45 600
www.ergotron.com
info.eu@ergotron.com

APAC Sales

Tokyo, Japan
www.ergotron.com
apaccustomerservice@ergotron.com

Worldwide OEM Sales

www.ergotron.com
info.oem@ergotron.com

